

令和 6 年 6 月 20 日現在

機関番号：15201

研究種目：若手研究

研究期間：2021～2023

課題番号：21K14182

研究課題名(和文) A Novel Pulse-Amplitude Modulation Control with Fuzzy-based Automatic Excitation Angle and Adaptive Deadtime for Motor Drives in Consideration of Core Loss

研究課題名(英文) A Novel Pulse-Amplitude Modulation Control with Fuzzy-based Automatic Excitation Angle and Adaptive Deadtime for Motor Drives in Consideration of Core Loss

研究代表者

NGUYEN Gia Minh Thao (Nguyen, Gia Minh Thao)

島根大学・学術研究院理工学系・准教授

研究者番号：40895710

交付決定額(研究期間全体)：(直接経費) 3,600,000円

研究成果の概要(和文)：ファジーベースの自動励磁角度方式を備えた新しいパルス振幅変調(PAM)制御を研究し、様々な回転速度での炭化ケイ素(SiC)インバータ励磁によるIPMSM駆動システムに実装した。更に、インバータ励磁下でのIPMSM駆動用の適応デッドタイム・アルゴリズムの開発にも成功した。また、モータのコア損、銅損、電圧・電流高調波、インバータ損を徹底的に評価した。更に、高スイッチング周波数下でのデッドタイムと制御サンプル時間の、モータコア損とインバータ損への相互影響を評価した。得られた結果の物理ベースの洞察と説明も提供した。その上、モータのコア損と高調波の数値解析用について、シミュレーションモデルを設計した。

研究成果の学術的意義や社会的意義

I proposed a novel PAM control with fuzzy-based automatic excitation angle and an adaptive deadtime algorithm, that are useful for IPMSM drives in electric vehicle with reduction of motor and inverter losses. The obtained results can be treated as reference for design of high-efficient motor drives.

研究成果の概要(英文)：- A novel pulse amplitude modulation (PAM) control with a fuzzy-based automatic excitation angle scheme was successfully developed and implemented in an experimental IPMSM drive under silicon carbide (SiC) inverter excitation at different rotational speeds. Furthermore, I successfully developed an adaptive dead-time algorithm for the IPMSM drive under inverter excitation.

- In addition, the IPMSM core loss, copper loss, voltage-current harmonics, and inverter loss were thoroughly evaluated. Mutual effects of the dead-time and control sample time at high switching frequencies on the motor core loss and inverter loss were assessed. Physic-based insights and explanations of the obtained results were also provided. Moreover, an isolated 2-phase buck-boost converter was researched for improvement of DC-bus control in motor drives. Simulation models in MATLAB and JMAG were also designed for numerical analysis on the core loss and harmonics of IPMSM. Ten related journal papers were published.

研究分野：Electrical Engineering and Control Systems

キーワード：PAM and fuzzy control IPMSM drive systems SiC/GaN power inverter Automatic excitation Adaptive deadtime Core and inverter losses Reduction of harmonics Finite element analysis

科研費による研究は、研究者の自覚と責任において実施するものです。そのため、研究の実施や研究成果の公表等については、国の要請等に基づくものではなく、その研究成果に関する見解や責任は、研究者個人に帰属します。

1. 研究開始当初の背景

The pulse-width modulation (PWM) inverter can generate the variable voltage and frequency required for the speed control of synchronous motor drive systems used in electric vehicles (EV) and mobile robots, but its output waveforms are typically complex and include a lot of harmonics. In fact, the harmonic components in motor currents, voltages and magnetic flux density are main reasons to increase the motor core and copper losses. Moreover, if the carrier frequency of the PWM motor inverter is increased for medium and high-speed modes, the inverter loss increases noticeably. To have the variable voltage, though the pulse-amplitude modulation (PAM) inverter needs an additional DC-DC converter, that is included in EV for the connection between the batteries and motor inverters, the PAM control can generate the simpler output waveforms with the substantially smaller harmonics if the excitation angle is adjusted properly.

In most EV, the wheel is indirectly connected to a high-speed motor via a mechanical gearbox, and a high-voltage DC-DC converter is usually used for the high-speed motor. In recent years, direct motor drives (without a gearbox for the connection between the motor and wheel) and synchronous in-wheel motors have been studied as potential solutions for EV and mobile robots in the future. The PAM inverter and efficient control algorithms combining with an appropriate excitation angle scheme can be used in these cases; as a result, the motor directly connected to or built in the wheel can be flexibly operated from low, medium to high speeds with reductions in the motor core, copper, and inverter losses. Besides, the deadtime of semiconductor devices, e.g. silicon insulated-gate bipolar transistor (Si-IGBT) or silicon carbide metal-oxide-semiconductor field-effect transistor (SiC-MOSFET), used in the motor inverter was investigated to have remarkable effects on the inverter loss, but detailed effects of the dead-time and control sample time on the IPMSM copper and core losses have not yet been thoroughly considered in existing studies.

2. 研究の目的

To effectively reduce the core loss, copper loss and inverter loss of the interior permanent magnet synchronous motor (IPMSM) drive system used in EV and mobile robots, this research proposal has introduced a novel PAM control method with an automatic excitation angle scheme based on fuzzy logic and twelve-step switching pattern. The proposed PAM method is also evaluated by finite element method (FEM) and can be implemented in experimental IPMSM drive systems without large computational cost.

Furthermore, an adaptive algorithm is proposed for automatically searching and setting an appropriate dead-time for the inverter in the IPMSM drive to achieve the smallest possible values of the total harmonic distortion (THD) of the motor current, which can help lower the motor core and copper losses. Besides, this dead-time algorithm can be suitably combined with the PWM and PAM methods for motor drives.

3. 研究の方法

I have designed a twelve-step switching pattern particularly suitable for the three-phase two-level inverter used in the experimental IPMSM drive system with the PAM control technique. In addition, a unique fuzzy logic controller (FLC) with the two inputs based on absolute values was proposed to automatically fine-tune the excitation angle in the PAM-based inverter, where the number of association rules of the FLC can be appropriately reduced for lowering the computational cost in implementation.

To clarify the reasons why the proposed PAM control has the smaller motor core and inverter losses than the PWM method, the mathematical and FEM models for the IPMSM testbed are researched. First, the control algorithms and IPMSM system are simulated in MATLAB; after that, the obtained motor current and voltage are imported to the FEM model in JMAG software for the calculation of the motor losses. The measured motor current and voltage are also imported to the FEM model for further evaluation. Lastly, an analytical model with consideration of mutual effects of the main components and operating conditions in a SiC-based IPMSM drive system on the inverter loss properties is studied to validate the measured results.

As an outcome of this research project, 10 related papers were published in peer-reviewed journals.

4. 研究成果

(1) Novel PAM control with fuzzy-based automatic excitation angle for SiC-based motor drive

I have proposed an improved PAM method based on fuzzy control for an experimental IPMSM drive system excited by the silicon carbide (SiC) inverter under load condition and various operating speeds. In detail, an automatic scheme with a twelve-step switching pattern is developed for real-time searching the optimal excitation angle of the SiC inverter under the PAM control method to minimize fluctuations of the dq -axis currents of the IPMSM, where the step-size angle is adjusted automatically and appropriately by the proposed FLC. With a novel design of the inputs and membership functions in the FLC based on absolute values, the number of fuzzy association rules is significantly reduced to 16 for obtaining good control performance with a small computational cost in implementation. As a result, the automatic angle excitation scheme can reduce harmonics in the motor current in experiments, from which it helps to reduce

the motor core and copper losses. The THD values of the measured motor current and voltage are also examined to validate the effectiveness of the proposed fuzzy-based PAM control in decreasing the IPMSM losses and inverter loss. Furthermore, the operating speed of the IPMSM is changed from 100 rpm to 1000 rpm for careful evaluation. The obtained results show that the proposed PAM control with the fuzzy-based automatic excitation angle scheme can decrease the losses in the SiC-based motor drive system. Moreover, the fuzzy-based PAM control can be appropriately applied for other motor drives used in various fields.

As shown in Fig. 1, the proposed PAM control with an automatic excitation angle scheme for the IPMSM drive has the following main steps.

Step 1: In load condition, the motor current errors in the dq -axis can be calculated in (1).

$$\begin{cases} e_{id}(j) = i_d^*(j) - i_d^{mes}(j) \\ e_{iq}(j) = i_q^*(j) - i_q^{mes}(j) \end{cases} \quad (1)$$

where j is the index of the sample time $T_{C1} = 0.1$ ms for the velocity control loop of the IPMSM drive, $i_d^*(j) = 0$, and $i_q^*(j)$ is the reference current in the q axis, which is the output of the torque controller for the motor speed control loop. Furthermore, $i_d^{mes}(j)$ and $i_q^{mes}(j)$ are the measured dq -axis currents of the IPMSM.

Step 2: The absolute average values of the motor current errors with the dq rotating frame in continuous time, $e_{id_abs}(t)$ and $e_{iq_abs}(t)$, are defined in (2) and (3), respectively.

$$e_{id_abs}(t) = \frac{1}{T_0} \int_0^{T_0} |e_{id}| dt \quad (2)$$

$$e_{iq_abs}(t) = \frac{1}{T_0} \int_0^{T_0} |e_{iq}| dt \quad (3)$$

In normal, the fundamental electrical frequency f_0 of the experimental IPMSM can be calculated by

$$f_0 = (n_{rpm} \times p) / 60 = (\omega \times p) / 2\pi \quad (4) \quad T_{C2} = 10 \times T_0 = 10 / f_0 = 600 / (n_{rpm} \times p) \quad (5)$$

where p is the number of pairs of poles (i.e., $p = 4$ in this study), n_{rpm} is the measured velocity in rpm of the IPMSM, and ω is the motor angular velocity in rad/s. For stability in operation of the experimental motor drive system, the second sample time T_{C2} utilized for the designed automatic excitation angle scheme based on fuzzy logic can be determined as ten times of the fundamental electrical period T_0 of the motor.

For example, when $n_{rpm} = 1000$ rpm and $p = 4$, from (5) it can be computed as $T_{C2} = 150$ ms (for the excitation angle scheme), which is much larger than $T_{C1} = 0.1$ ms (for the velocity control loop) as required.

The k -th absolute average values of the d -axis current error e_{id_abs} and q -axis current error e_{iq_abs} of the IPMSM in discrete time of T_{C2} can be calculated by (6) and (7), respectively. It is noted that the index j corresponds to the fixed sample time $T_{C1} = 0.1$ ms for the velocity control loop defined in Step 1, and the index k corresponds to the other sample time T_{C2} for the automatic excitation angle scheme (e.g., $T_{C2} = 150$ ms when $n_{rpm} = 1000$ rpm).

$$e_{id_abs}(k) = \frac{1}{N_s} \sum_{j=1}^{N_s} |e_{id}(j)| \quad (6)$$

$$e_{iq_abs}(k) = \frac{1}{N_s} \sum_{j=1}^{N_s} |e_{iq}(j)| \quad (7)$$

where N_s is a positive integer value determined according to the following formulas with the *round* function in (8). For example, when $T_{C1} = 0.1$ ms and $T_{C2} = 150$ ms, it is derived as $N_s = 1500$.

$$N_s = \text{round}\left(\frac{T_{C2}}{T_{C1}}\right) \quad (8)$$

$$e_{i_abs}(k) = \sqrt{e_{id_abs}^2(k) + e_{iq_abs}^2(k)} \quad (9)$$

From (6) and (7), the k -th absolute average value of the dq -axis current error $e_{i_abs}(k)$ of the motor in the discrete time of T_{C2} is computed in (9).

In consideration of the decrease of the motor core and copper losses, the key goal of searching the optimal excitation angle β_{opt}^* of the SiC-MOSFET inverter is to minimize $e_{i_abs}(k)$ as possible, as expressed in (10) and Fig. 2.

$$\beta^*(k) \rightarrow \beta_{opt}^*, \text{ where } e_{i_abs}(k) \rightarrow \min \quad (10)$$

Step 3: The values of $\Delta e_{i_abs}(k)$ and $\Delta \beta^*(k)$ with the sample time of T_{C2} can be calculated in (11).

$$\begin{cases} \Delta e_{i_abs}(k) = e_{i_abs}(k) - e_{i_abs}(k-1) \\ \Delta \beta^*(k) = \beta^*(k) - \beta^*(k-1) \end{cases} \quad (11)$$

For simplicity, the initial values in implementation are $e_{i_abs}(k=0) = 0$ and $\beta^*(k=0) = 120^\circ$.

Step 4: In this step, the optimal excitation angle can be searched as described in Fig. 3, where $\Delta \delta(k)$ is a changeable step size for adjusting the desired excitation angle $\beta^*(k)$. It is noted that $\Delta \delta(k)$ is automatically tuned by the proposed 16-rule FLC depicted in Fig. 4, and its initial value is $\Delta \delta(k=0) = 0$.

Step 5: For stability in operation, the desired excitation angle $\beta^*(k)$ is limited as $120^\circ \leq \beta^*(k) \leq 180^\circ$.

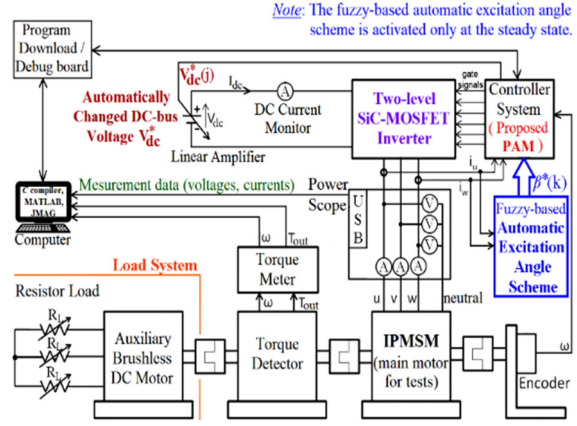

Fig. 1. IPMSM drive system with proposed PAM control.

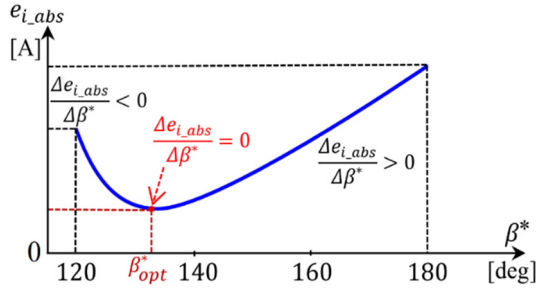

Fig. 2. Automatic search of optimal excitation angle for SiC inverter utilized in IPMSM drive.

According to our previous studies, the optimal excitation angle is often in a range of 120° – 150° . Thus, in this research, the searching range of optimal excitation angle is set as 120° – 150° . The experimental results of the IPMSM drive with the proposed PAM control are shown in Figs. 5 and 6.

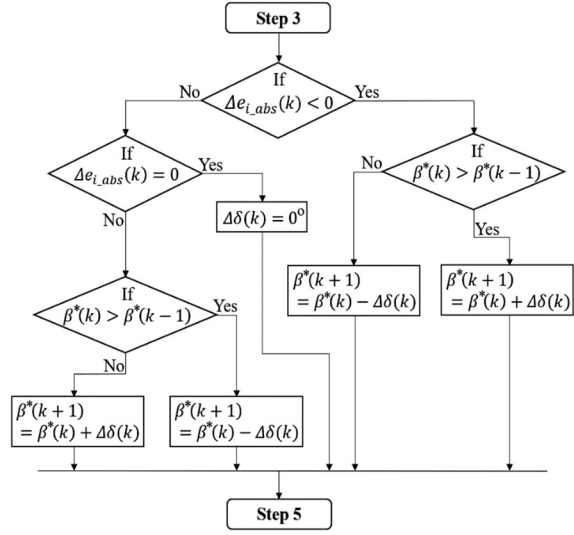
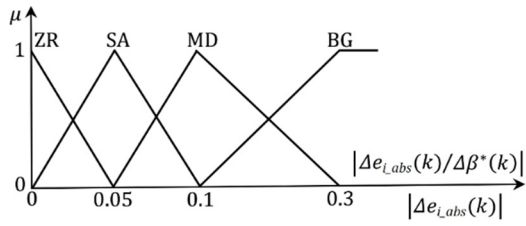
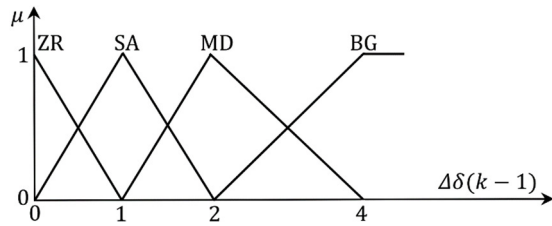

Fig. 3. Flowchart of searching optimal excitation angle.



(a) Membership functions of first input



(b) Membership functions of second input

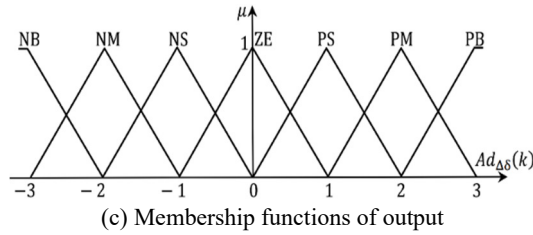

(c) Membership functions of output

$Ad_{\Delta\delta}(k)$	$\Delta\delta(k-1)$				
	ZR	SA	MD	BG	
$ \Delta e_{i_{abs}}(k)/\Delta\beta^*(k) $ or $ \Delta e_{i_{abs}}(k) $	ZR	ZR	NS	NM	NB
	SA	PS	ZR	NS	NM
	MD	PB	PM	PS	ZR
	BG	PB	PB	PM	PS

(d) Fuzzy association rules

Fig. 4. Design of proposed 16-rule FLC for automatically adjusting step-size $\Delta\delta(k)$ in Step 4 and Fig. 3.

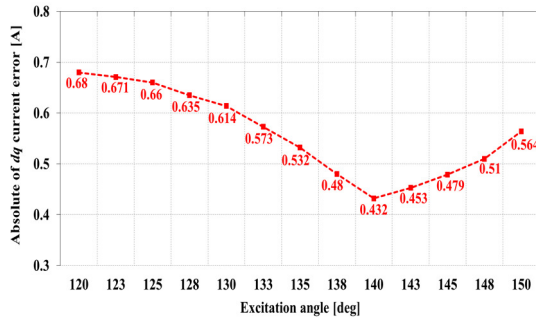

(a) Absolute value of dq -axis current error $e_{i_{abs}}(k)$

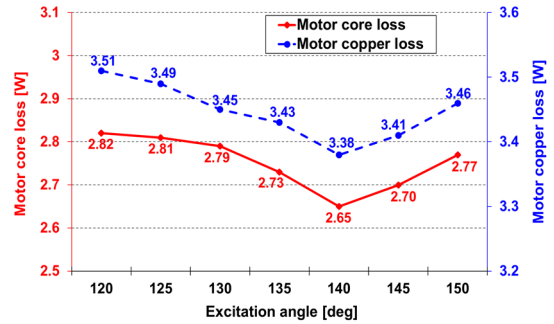

(b) Measured IPMSM core loss and copper loss

Fig. 5. Experimental results with fixed IPMSM speed of 1000 rpm and different excitation angles.

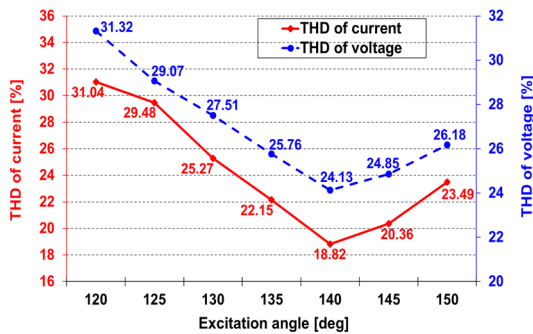

(a) THD of IPMSM phase current and voltage at speed of 1000 rpm and different excitation angles

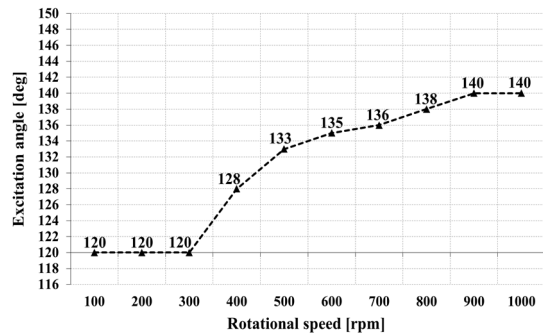

(b) Searched optimal excitation angles of PAM-based IPMSM drive at various speeds of 100 to 1000 rpm

Fig. 6. Experimental results of THD of motor current and voltage and searched optimal excitation angles.

(2) Adaptive dead-time algorithm for inverter to decrease motor current harmonics and losses

Similarly, to reduce harmonics in the IPMSM current, the main objective of seeking the best dead-time of the inverter is to minimize the motor current error $e_i(k)$ as possible, as shown in (12), Figs. 7 and 8, where $\Delta e_i(k) = e_i(k) - e_i(k-1)$, and $\Delta\alpha = 0.25 \mu\text{s}$ is the step-size to adjust the desired dead-time $\beta^*(k)$.

$$\beta^*(k) \rightarrow \beta_{best}^*, \text{ where the motor current error } e_i(k) \rightarrow \min \quad (12)$$

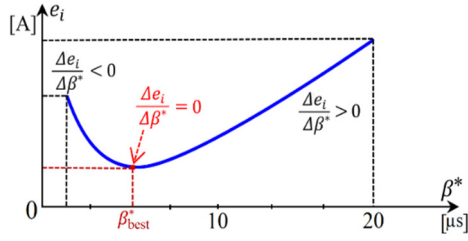

Fig. 7. Automatic search of best dead-time β^* for inverter used in IPMSM drive.

In this research, the values of e_i and THD of the IPMSM current with dissimilar dead-times of 0–16 μs are evaluated in MATLAB/Simulink. Then, $\beta^*(k) = 1 \mu\text{s}$ is found as the best dead-time value for our IPMSM drive system excited by a 3-phase IGBT inverter. For further evaluation, the proposed FLC can be suitably modified to automatically tune the step-size $\Delta\alpha(k)$.

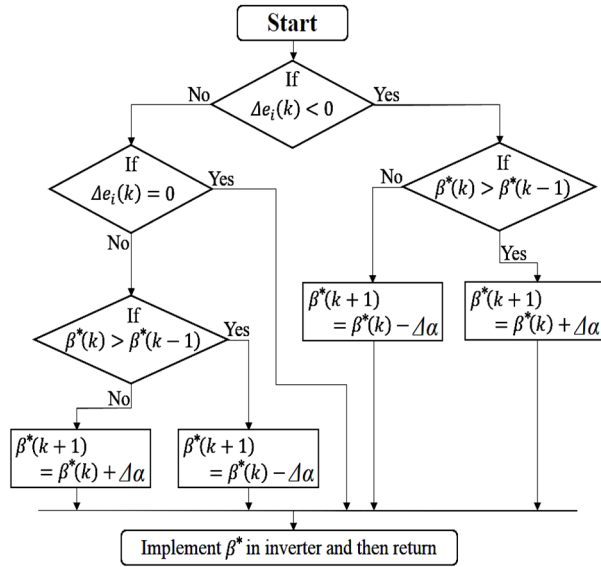

Fig. 8. Flowchart of adaptive dead-time algorithm for inverter.

(3) Mutual effects of dead-time, control sample time and carrier frequency on losses in motor drive

I experimentally analyzed the core loss characteristics of an IPMSM excited by a SiC inverter with the sinusoidal pulse-width modulation (PWM) and high modulation index of 1.1 considering the mutual effects of the high carrier frequencies of up to 200 kHz, different dead-times of 250 and 1000 ns, control sample times of 100–1000 μs , and stator temperature (see Figs. 9 and 10). The experimental IPMSM drive system is operated in load condition with a torque of 1.05 Nm and rotational velocity of 1500 rpm. Furthermore, the ringing phenomenon and rise time in the motor voltage are measured and analyzed using a high-resolution oscilloscope that has a superior sampling rate of up to 5 giga-samples per second, which helps to thoroughly examine the impact of the SiC inverter excitation on the motor core loss. The relations of the THD of the measured motor voltage and current and the distortions in the magnetic flux density to the IPMSM core loss properties are also evaluated. Besides, the insights and explanations were provided.

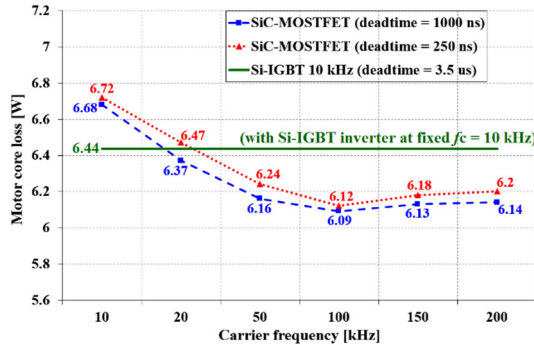

Fig. 9. Measured IPMSM core loss with different dead-times and carrier frequencies.

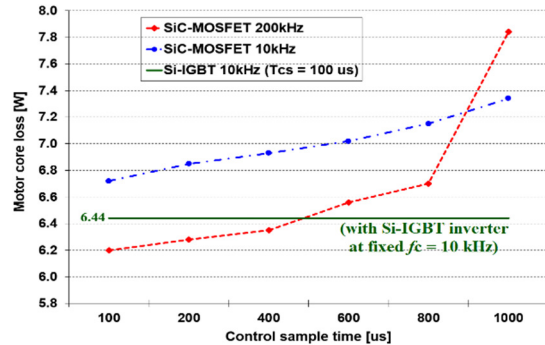

Fig. 10. Measured IPMSM core loss with different control sample times and carrier frequencies.

(4) Current harmonics mitigation with auto-tuning PD-fuzzy controller to reduce motor losses

In addition, I have introduced an auto-tuning proportional differential (PD) controller based on fuzzy logic to considerably decrease the 5th and 7th current harmonics in the experimental IPMSM drive system excited by a two-level SiC-MOSFET inverter. In the proposed control scheme, a unique 9-rule FLC was designed to automatically and suitably adjust the four key coefficients of the four PD controllers for the 5th and 7th dq harmonic currents (i.e., K_{id5} , K_{iq5} , K_{id7} , and K_{iq7}) according to various operating conditions of the motor system in real time. Moreover, the PD-fuzzy control scheme was successfully implemented without a large computational cost, where the control sample time is fast as 100 μs . The experimental results with the SiC-based IPMSM drive system under a high switching frequency of 200 kHz in load condition have confirmed the performance of the proposed PD-fuzzy controller in substantially reducing the harmonics and THD of the IPMSM current as well as the motor copper loss and SiC inverter loss.

5. 主な発表論文等

〔雑誌論文〕 計10件（うち査読付論文 10件 / うち国際共著 6件 / うちオープンアクセス 6件）

1. 著者名 成瀬 賢哉、藤崎 敬介、Nguyen Gia Minh Thao	4. 巻 143
2. 論文標題 五次調波重畳PWM制御によるモータ駆動システムの損失低減	5. 発行年 2023年
3. 雑誌名 電気学会論文誌D（産業応用部門誌）	6. 最初と最後の頁 273～280
掲載論文のDOI（デジタルオブジェクト識別子） 10.1541/ieejias.143.273	査読の有無 有
オープンアクセス オープンアクセスではない、又はオープンアクセスが困難	国際共著 -
1. 著者名 Nguyen Gia Minh Thao、Ton-That Long、Keisuke Fujisaki	4. 巻 19
2. 論文標題 Experimental study of mutual effects of high carrier frequency, dead-time and control sample time on IPMSM core loss under SiC inverter excitation	5. 発行年 2023年
3. 雑誌名 Results in Engineering	6. 最初と最後の頁 101278 (p.1～23)
掲載論文のDOI（デジタルオブジェクト識別子） 10.1016/j.rineng.2023.101278	査読の有無 有
オープンアクセス オープンアクセスとしている（また、その予定である）	国際共著 該当する
1. 著者名 Arockia Doss Arockia Selvakumar、Lingampally Pavan Kalyan、Nguyen Gia Minh Thao、Schilberg Daniel	4. 巻 19
2. 論文標題 A comprehensive review of wearable assistive robotic devices used for head and neck rehabilitation	5. 発行年 2023年
3. 雑誌名 Results in Engineering	6. 最初と最後の頁 101306 (p.1～14)
掲載論文のDOI（デジタルオブジェクト識別子） 10.1016/j.rineng.2023.101306	査読の有無 有
オープンアクセス オープンアクセスとしている（また、その予定である）	国際共著 該当する
1. 著者名 Nguyen Tien-The、Nguyen Gia Minh Thao、Bui Van-Dai、Cha Honnyong	4. 巻 72
2. 論文標題 Novel Automatic Current Balancing of Two-Phase Isolated Buck-Boost Converters	5. 発行年 2024年
3. 雑誌名 IEEE Transactions on Industrial Electronics	6. 最初と最後の頁 10075～10085
掲載論文のDOI（デジタルオブジェクト識別子） 10.1109/TIE.2023.3340218	査読の有無 有
オープンアクセス オープンアクセスではない、又はオープンアクセスが困難	国際共著 該当する

1. 著者名 荻島 規宏、Nguyen Gia Minh Thao、藤崎 敬介	4. 巻 144
2. 論文標題 GaN-FETインバータ励磁下における高周波電磁気リング現象の解明	5. 発行年 2024年
3. 雑誌名 電気学会論文誌D (産業応用部門誌)	6. 最初と最後の頁 1~7
掲載論文のDOI (デジタルオブジェクト識別子) 10.1541/ieejias.144.1	査読の有無 有
オープンアクセス オープンアクセスではない、又はオープンアクセスが困難	国際共著 -

1. 著者名 Ogishima Norihiro、Nguyen Gia Minh Thao、Fujisaki Keisuke	4. 巻 217
2. 論文標題 Analysis of high frequency electromagnetic ringing phenomenon under GaN FET inverter excitation	5. 発行年 2024年
3. 雑誌名 Electrical Engineering in Japan	6. 最初と最後の頁 e23464 (pp.1~8)
掲載論文のDOI (デジタルオブジェクト識別子) 10.1002/eej.23464	査読の有無 有
オープンアクセス オープンアクセスとしている (また、その予定である)	国際共著 -

1. 著者名 Huong Dinh Cong、Huynh Van Thanh、Nguyen Gia Minh Thao、Dang Tien Phuc、Trinh Hieu	4. 巻 71
2. 論文標題 State Estimation for a New Battery and Motor Circuit Model of an Electric Vehicle Using Event-Triggered Functional Interval Observers	5. 発行年 2024年
3. 雑誌名 IEEE Transactions on Circuits and Systems I: Regular Papers	6. 最初と最後の頁 421~430
掲載論文のDOI (デジタルオブジェクト識別子) 10.1109/TCSI.2023.3324248	査読の有無 有
オープンアクセス オープンアクセスではない、又はオープンアクセスが困難	国際共著 該当する

1. 著者名 Nguyen Gia Minh Thao、Long Ton-That、Keisuke Fujisaki、Kenya Naruse、Haruo Naitoh	4. 巻 12
2. 論文標題 Conceptual Diagrams of Extended Building Factor for Analysis and Evaluation of Factors on Core Loss Density Increase in IPMSM	5. 発行年 2023年
3. 雑誌名 IEEJ Journal of Industry Applications	6. 最初と最後の頁 12~25
掲載論文のDOI (デジタルオブジェクト識別子) 10.1541/ieejjia.21012321	査読の有無 有
オープンアクセス オープンアクセスとしている (また、その予定である)	国際共著 該当する

1. 著者名 Kenya Naruse, Fujisaki Keisuke, Nguyen Gia Minh Thao	4. 巻 45
2. 論文標題 Iron Loss Evaluation in Consideration of Anomalous Loss for PAM Inverter Excitation in Finite Element Analysis	5. 発行年 2021年
3. 雑誌名 Journal of the Magnetics Society of Japan	6. 最初と最後の頁 106 ~ 111
掲載論文のDOI (デジタルオブジェクト識別子) 10.3379/msjmag.2107R007	査読の有無 有
オープンアクセス オープンアクセスとしている (また、その予定である)	国際共著 -

1. 著者名 Hsieh Min-Fu, Ngo Duc-Kien, Nguyen Gia Minh Thao	4. 巻 11
2. 論文標題 Flux Intensifying Feature of Permanent Magnet Assisted Synchronous Reluctance Motor with High Torque Density	5. 発行年 2022年
3. 雑誌名 Electronics	6. 最初と最後の頁 397 (pp.1 ~ 16)
掲載論文のDOI (デジタルオブジェクト識別子) 10.3390/electronics11030397	査読の有無 有
オープンアクセス オープンアクセスとしている (また、その予定である)	国際共著 該当する

[学会発表] 計14件 (うち招待講演 2件 / うち国際学会 10件)

1. 発表者名 Dai-Van Vo, Nguyen Gia Minh Thao, Minh-Khai Nguyen, et.al.
2. 発表標題 A Novel Single-Phase Seven-Level Boost Inverter with Simplified Control
3. 学会等名 2023 IEEE International Conference on Energy Technologies for Future Grids (IEEE ETFG 2023) (国際学会)
4. 発表年 2023年

1. 発表者名 Nguyen Gia Minh Thao
2. 発表標題 New Auto-Tuning PD-Fuzzy Control of Current Harmonics to Lower Losses in Motor Drive Systems under SiC Inverter Excitation
3. 学会等名 2023 4th International Conference on Robotics, Intelligent Automation and Control Technologies (RIACT 2023) (招待講演) (国際学会)
4. 発表年 2023年

1. 発表者名 Nguyen Gia Minh Thao, Norihiro Ogishima, Keisuke Fujisaki
2. 発表標題 Investigation of Motor Core Losses under PAM and PWM Inverter Excitations at Various Speeds in Experiments and Finite Element Analysis
3. 学会等名 2023年電気学会産業応用部門大会
4. 発表年 2023年

1. 発表者名 Yussuf Shakhin, Kulash Talapiden, Nguyen Gia Minh Thao, Mehdi Bagheri, and Ton Duc Do
2. 発表標題 Analysis and Design Optimization of Surface Permanent Magnet Motor to Improve Torque Density and Ripple
3. 学会等名 11th IEEE International Conference on Power Electronics - ECCE Asia (ICPE 2023-ECCE Asia) (国際学会)
4. 発表年 2023年

1. 発表者名 Xuanda Hou, Kazuya Kawai, Hiroshi Dozono, Kazuhiro Muramatsu, Norihiro Ogishima, Yoshimoto Kawakita, Nguyen Gia Minh Thao, et.al.
2. 発表標題 Electromagnetic Field Analysis on Ringing Phenomenon of Inductor Driven by Inverter Considering Stray Capacitance
3. 学会等名 2023 IEEE International Magnetics Conference (INTERMAG 2023) (国際学会)
4. 発表年 2023年

1. 発表者名 Nguyen Gia Minh Thao, Keisuke Fujisaki, Duc-Kien Ngo, Kenya Naruse
2. 発表標題 Iron Loss Properties of Amorphous Ring under High-Frequency SiC Inverter Excitation with Different Dead-times Using High Sampling Rate
3. 学会等名 2022 IEEE International Power Electronics Conference (IPEC 2022 -ECCE Asia-), pp. 2580-2584, Himeji, Japan, DOI: 10.23919/IPEC-Himeji2022-ECCE53331.2022.9807018 (国際学会)
4. 発表年 2022年

1. 発表者名 Nguyen Gia Minh Thao, Kenya Naruse, and Keisuke Fujisaki
2. 発表標題 Reduction of Harmonics and Inverter Temperature in Experimental GaN-Based Motor Drive System at High Frequencies Using LC Filter
3. 学会等名 2022 IEEE 9th International Conference on Communications and Electronics (ICCE 2022), pp. 507-512, Nha Trang, Vietnam, DOI: 10.1109/ICCE55644.2022.9852038 (国際学会)
4. 発表年 2022年

1. 発表者名 Dai-Van Vo, Duong Truong-Duy, Minh-Khai Nguyen, Nguyen Gia Minh Thao, Tan-Tai Tran, Young-Cheol Lim, and Joon-Ho Choi
2. 発表標題 A Single-Phase Transformerless Buck-Boost Inverter with Common Ground Feature
3. 学会等名 2022 IEEE 9th International Conference on Communications and Electronics (ICCE 2022), pp. 507-512, Nha Trang, Vietnam, DOI: 10.1109/ICCE55644.2022.9852077 (国際学会)
4. 発表年 2022年

1. 発表者名 Nguyen Gia Minh Thao, Ton Duc Do, Duc-Kien Ngo, and Keisuke Fujisaki
2. 発表標題 Novel Auto-Tuning PD-Fuzzy Control of Current Harmonics to Reduce Losses in Motor Drive Systems Excited by SiC-MOSFET Inverter
3. 学会等名 2023 IEEE SICE International Symposium on Control Systems (ISCS 2023), pp. 103-110, Kusatsu, Japan, DOI: 10.23919/siceiscs57194.2023.10079198 (国際学会)
4. 発表年 2023年

1. 発表者名 Nguyen Gia Minh Thao, Keisuke Fujisaki, Norihiro Ogishima
2. 発表標題 Motor Performance Evaluation under Changes in Inverters and Materials インバータと材料変更時のモータ性能評価
3. 学会等名 2022 IEEJ Industry Applications Society Conference, organized section S6, paper no.3-S6-4, pp. 1-2, Tokyo, Japan (招待講演)
4. 発表年 2022年

1. 発表者名 Nguyen Gia Minh Thao, Hiroyuki Kojima, Takaya Sugimoto, Keisuke Fujisaki
2. 発表標題 Investigation of Effects of Rising and Falling Time, Ringing Phenomena and Dead Time in GaN Inverter on Iron Loss with Very High Sampling Rate
3. 学会等名 2021 IEEE International Symposium on Electrical and Electronics Engineering (ISEE) (国際学会)
4. 発表年 2021年

1. 発表者名 Nguyen Gia Minh Thao, Long Ton-That, 藤崎 敬介、成瀬 賢哉、内藤 治夫
2. 発表標題 IPMSMのコア損の拡張ビルディングファクタ評価
3. 学会等名 2021年電気学会産業応用部門大会
4. 発表年 2021年

1. 発表者名 成瀬 賢哉、藤崎 敬介、Nguyen Gia Minh Thao
2. 発表標題 GaN-FETインバータ励磁下のN0リングにおけるLCフィルターによるキャリア鉄損とリング鉄損の低減評価
3. 学会等名 2021年電気学会産業応用部門大会
4. 発表年 2021年

1. 発表者名 Nguyen Gia Minh Thao, Van-Long Pham, Kutsukake Asuka, Keisuke Fujisaki, Ton Duc Do
2. 発表標題 Mutual Impacts of Different Dead-times and Control Sample Times on SiC Inverter Loss in Experimental Motor Drive at High Carrier Frequencies
3. 学会等名 2024 IEEE 10th International Conference on Communications and Electronics (IEEE ICCE 2024) (国際学会)
4. 発表年 2024年

〔図書〕 計1件

1. 著者名 Nguyen Gia Minh Thao, Ton Duc Do, Keisuke Fujisaki	4. 発行年 2024年
2. 出版社 Springer Nature	5. 総ページ数 15
3. 書名 Improved PAM Control with Fuzzy-Based Automatic Angle Excitation for Motor Drives Excited by SiC Inverter in Consideration of Core Loss (chapter 12 in book titled "Handbook of Magnetic Material for Motor Drive Systems - 2nd Edition")	

〔産業財産権〕

〔その他〕

-

6. 研究組織

	氏名 (ローマ字氏名) (研究者番号)	所属研究機関・部局・職 (機関番号)	備考
研究協力者	Do Duc Ton (Do Duc Ton)	Nazarbayev University	
研究協力者	Ton-That Long (Ton-That Long)	Vietnam National University HCM	
研究協力者	藤崎 敬介 (Fujisaki Keisuke) (80373869)	豊田工業大学・電磁システム研究室・教授 (33924)	
研究協力者	Ngo Duc-Kien (Ngo Duc-Kien)	The University of Danang	
研究協力者	Nguyen The-Tien (Nguyen The-Tien)	Wayne State University	

6. 研究組織（つづき）

	氏名 (ローマ字氏名) (研究者番号)	所属研究機関・部局・職 (機関番号)	備考
研究協力者	Trinh Hieu (Trinh Hieu)	Deakin University	
研究協力者	Hsieh Min-Fu (Hsieh Min-Fu)	National Cheng Kung University	
研究協力者	Arockia Doss Arockia Selvakumar (Arockia Doss Arockia Selvakumar)	Vellore Institute of Technology	
研究協力者	Cha Honnyong (Cha Honnyong)	Kyungpook National University	
研究協力者	Huynh Van Thanh (Huynh Van Thanh)	Deakin University	

7. 科研費を使用して開催した国際研究集会

〔国際研究集会〕 計0件

8. 本研究に関連して実施した国際共同研究の実施状況

共同研究相手国	相手方研究機関			
ベトナム	Vietnam National University-Ho Chi Minh	The University of Danang	Industrial University of HCMC	
韓国	Chonnam National University	Kyungpook National University		
カザフスタン	Nazarbayev University			
その他の国・地域	National Cheng Kung University (Taiwan)			
米国	Wayne State University	General Motors Company		

共同研究相手国	相手方研究機関			
オーストラリア	Deakin University			
インド	Vellore Institute of Technology	SASTRA Deemed University		